

Varenummer: 203380M24150B1U
 Beskrivelse: E+G Justerfod
 GN 33-80-M24-150-B1-U, Rustfast
 Note: U Uden møtrik, sekskant i toppen, spændeflade i bunden

Mål

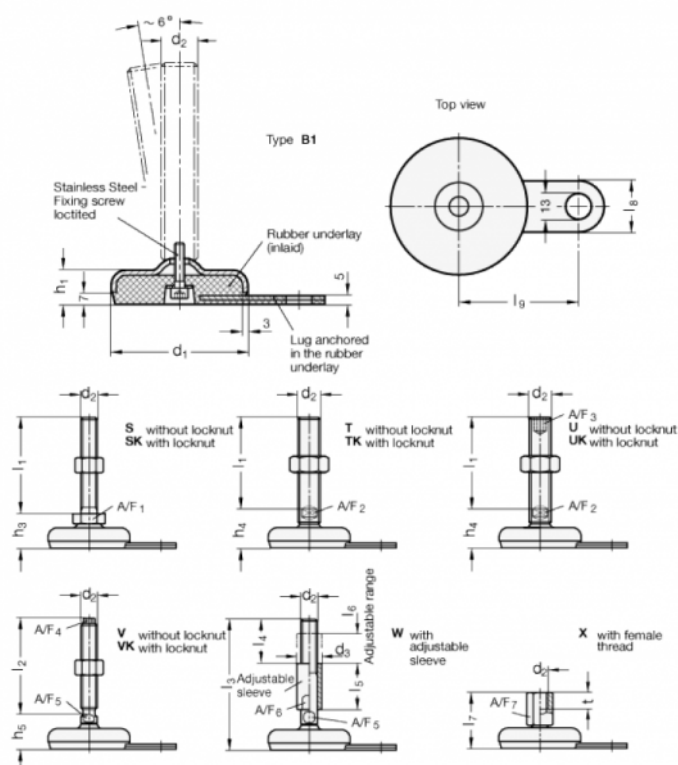

A/F2 = 19	l9 = 70
A/F3 = 12	
d1 = 80	
d2 = M24	
h1 = 18	
h3 = 38	
l1 = 150	
l8 = 30	